



**MASTERPLAN OF THE ENTRANCE TO THE TIRANA PARK  
AND ARCHITECTURAL PROJECT IDEAS FOR TWO PUBLIC BUILDINGS:  
THE PUBLIC SERVICE CENTER AND THE GENERAL DIRECTORATE OF THE STATE POLICE**

**JDS**  
JDS ARCHITECTS

 **deastudio**  
[www.deastudio.com](http://www.deastudio.com)

**TIRANA PARK CITY**



ORTHOPHOTO MAP

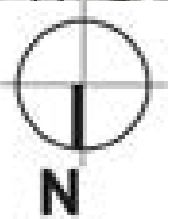

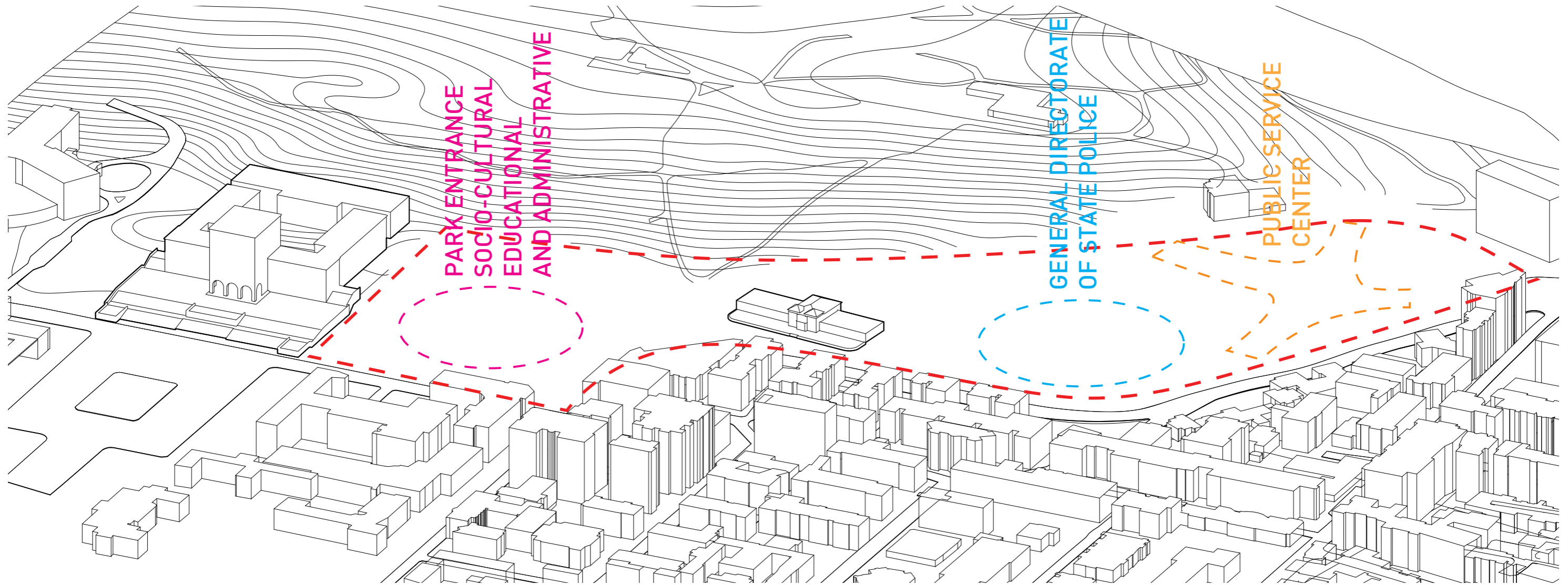

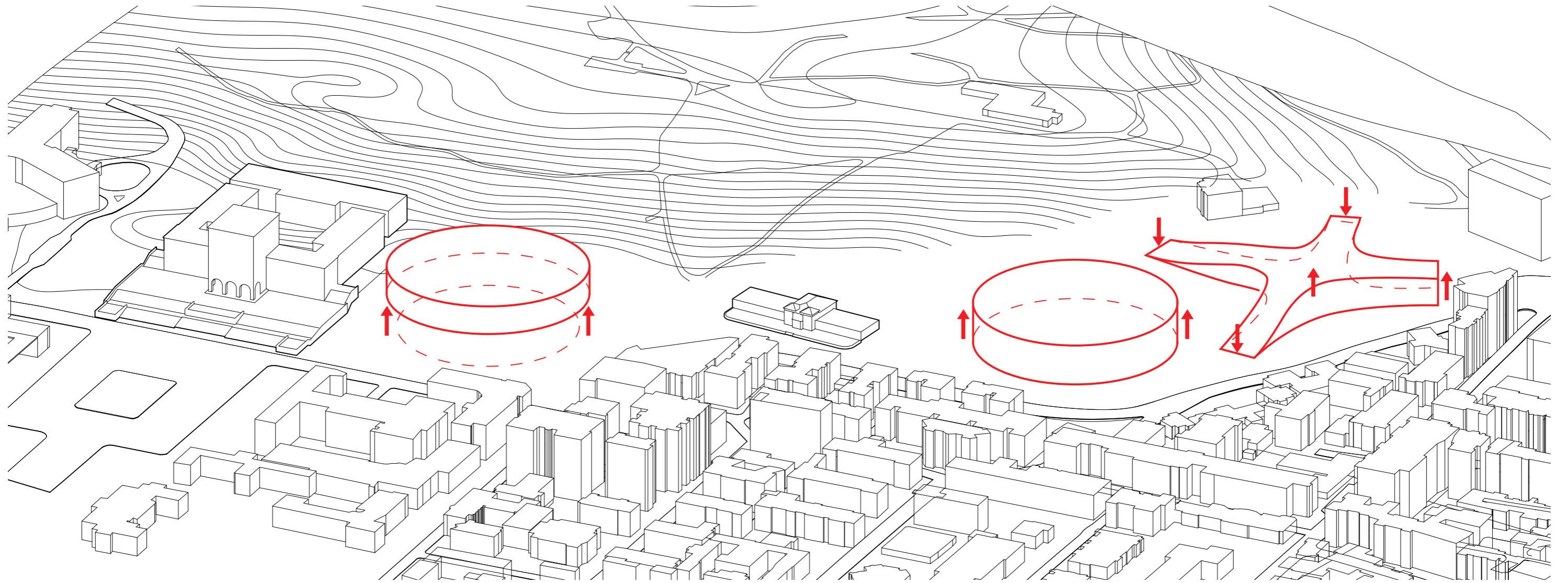

PULLING

JDS + DEA

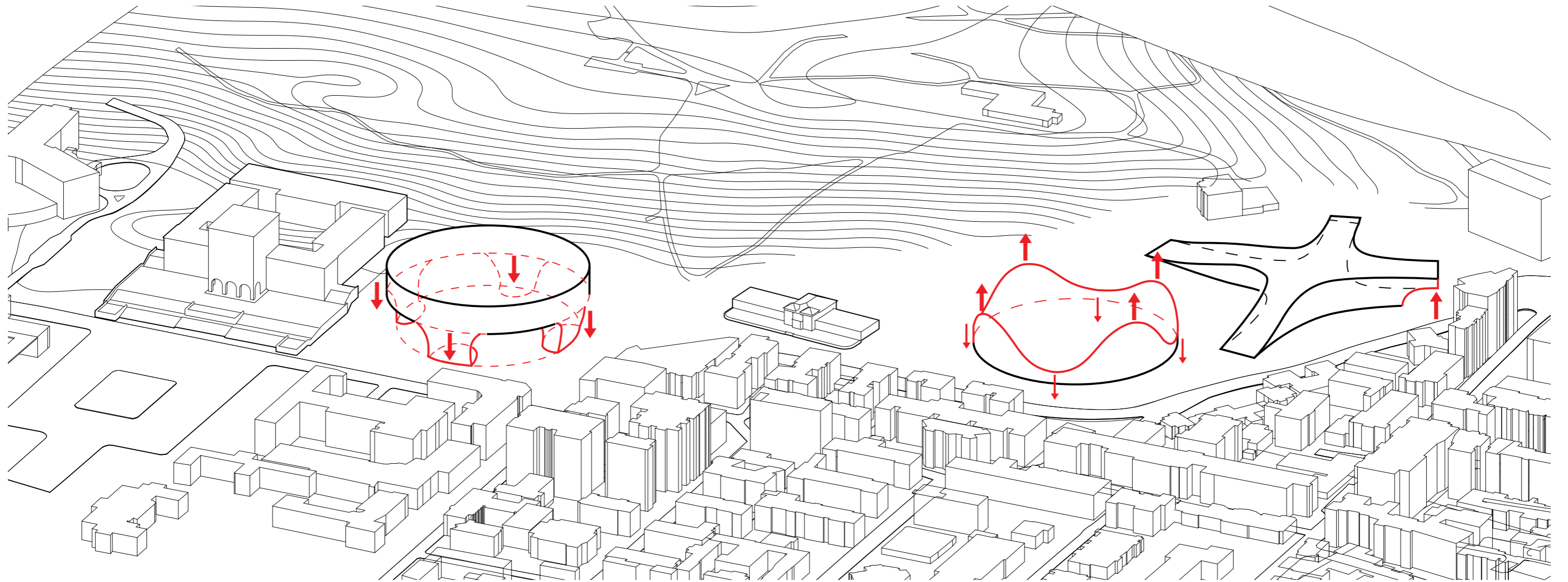

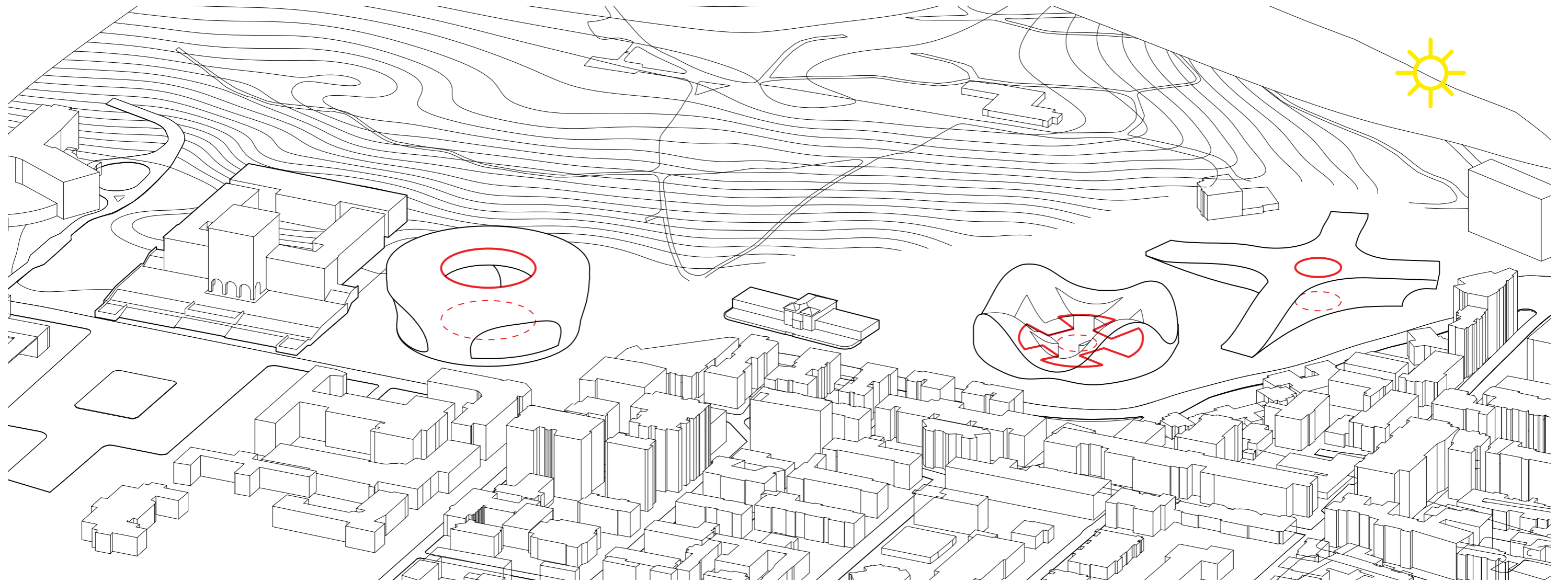

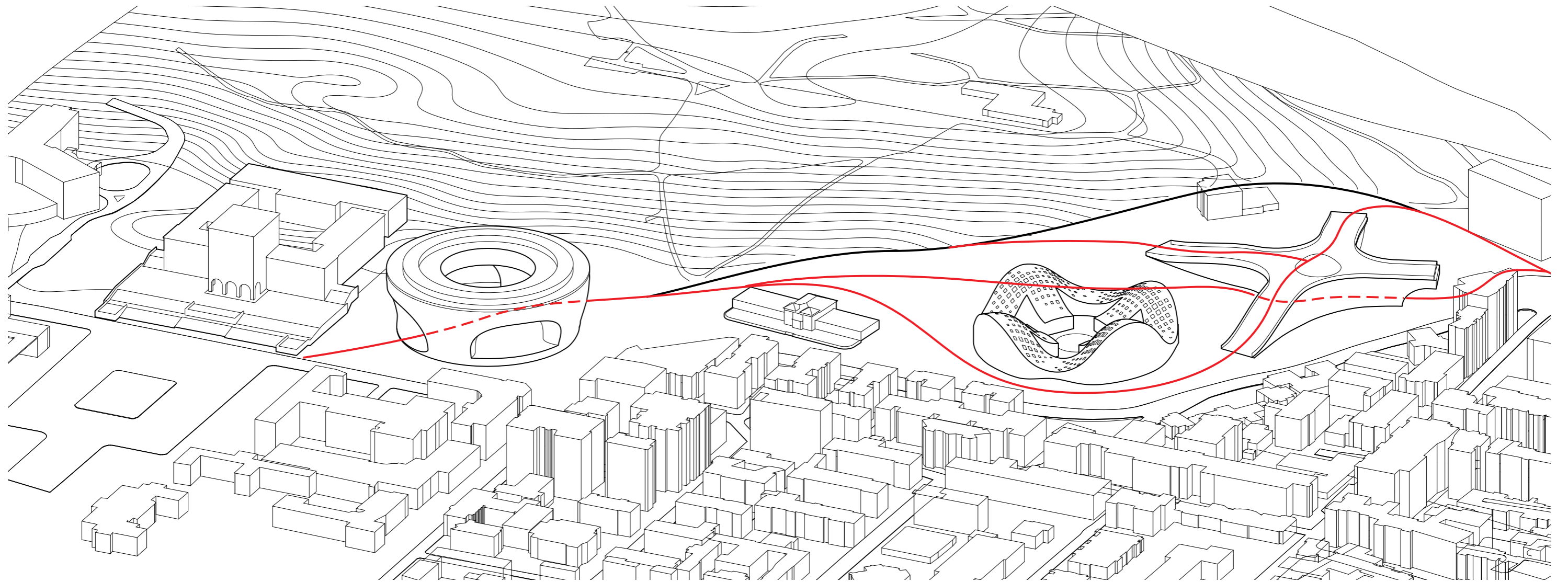



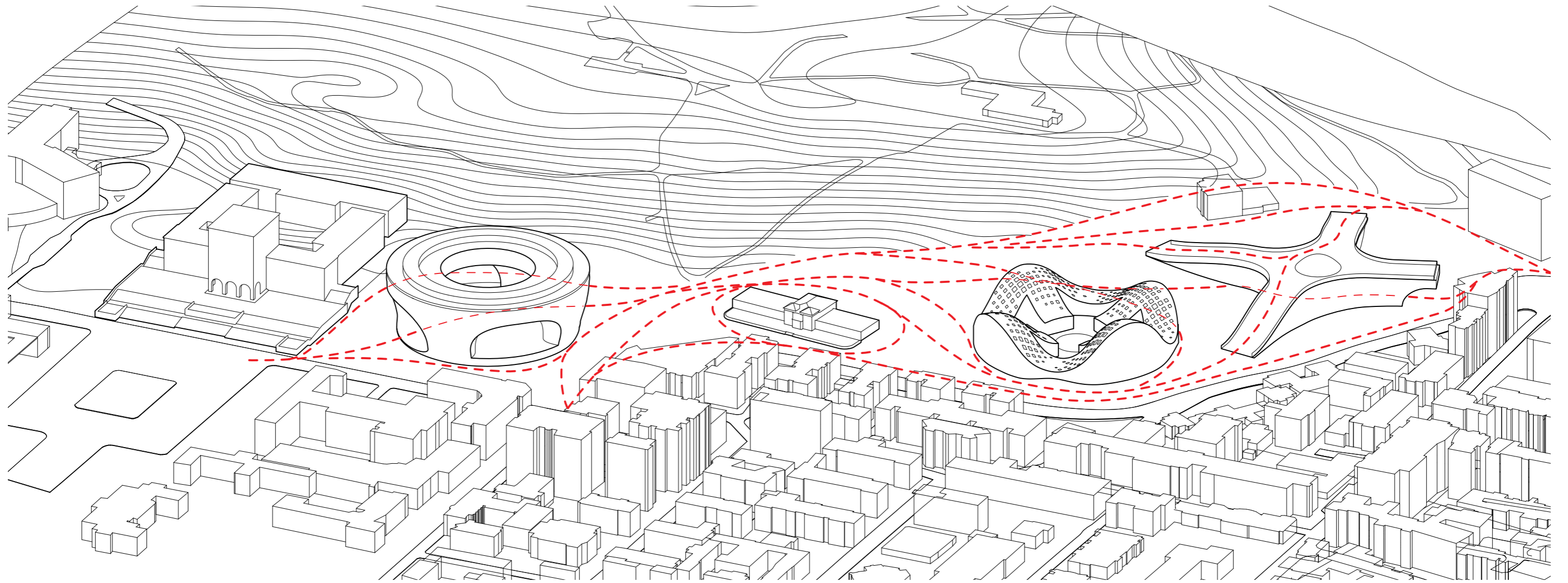

CIRCULATION FLOW

JDS + DEA

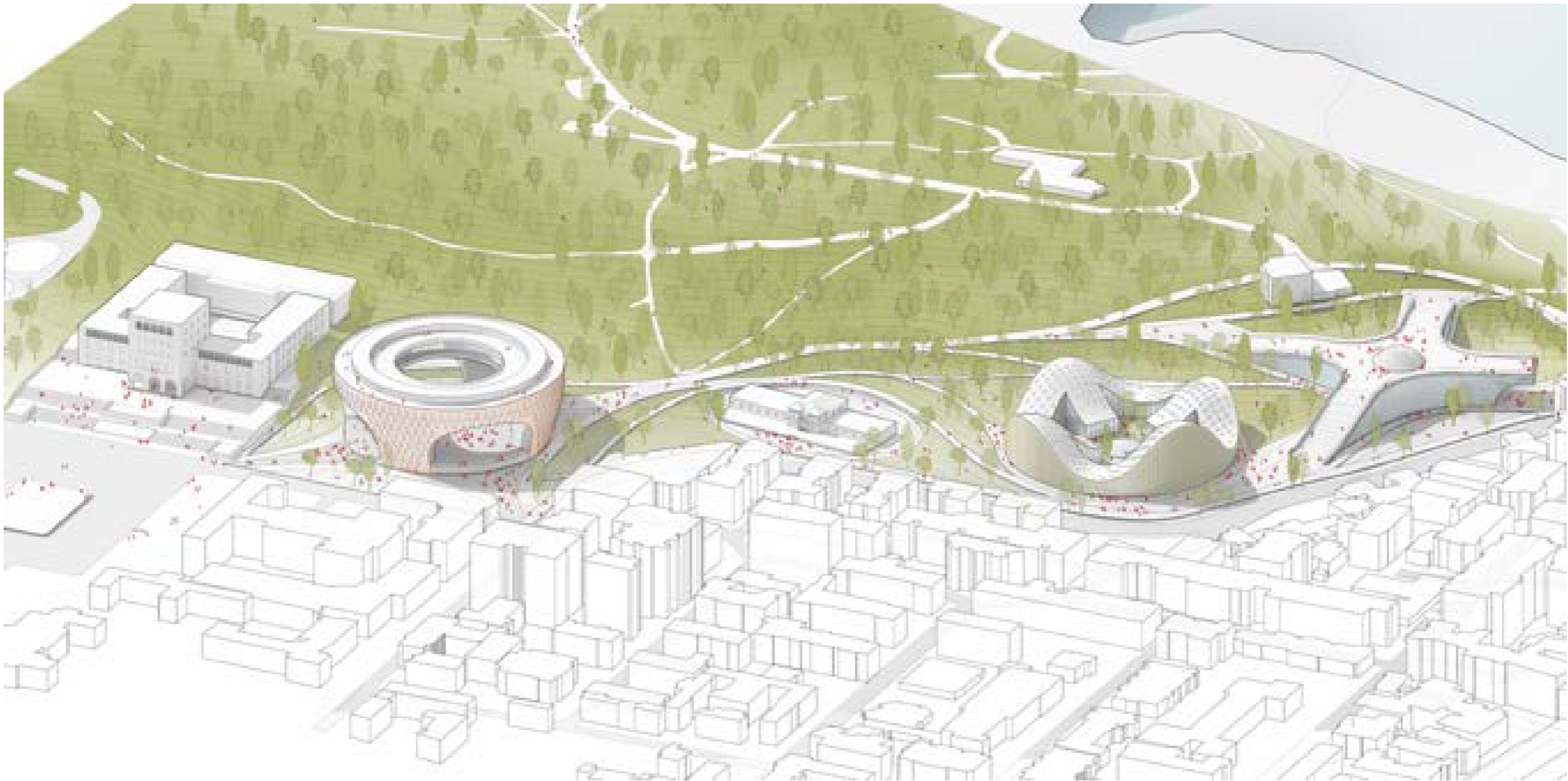

MASTERPLAN AXONOMETRY



MASTERPLAN

JDS + DEA

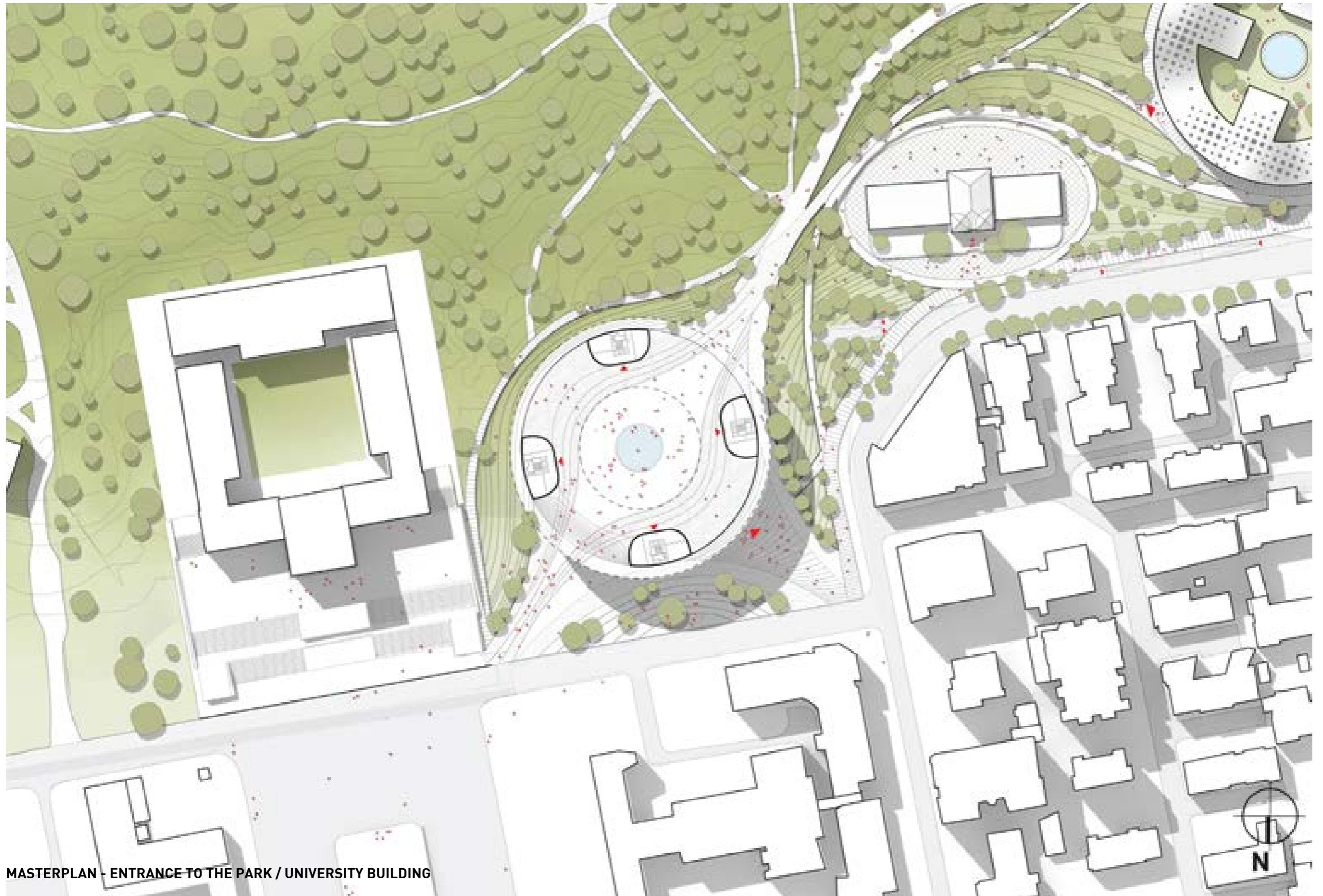

MASTERPLAN - ENTRANCE TO THE PARK / UNIVERSITY BUILDING



ENTRANCE TO THE PARK / UNIVERSITY BUILDING



ENTRANCE TO THE PARK / UNIVERSITY BUILDING



ENTRANCE TO THE PARK / UNIVERSITY BUILDING

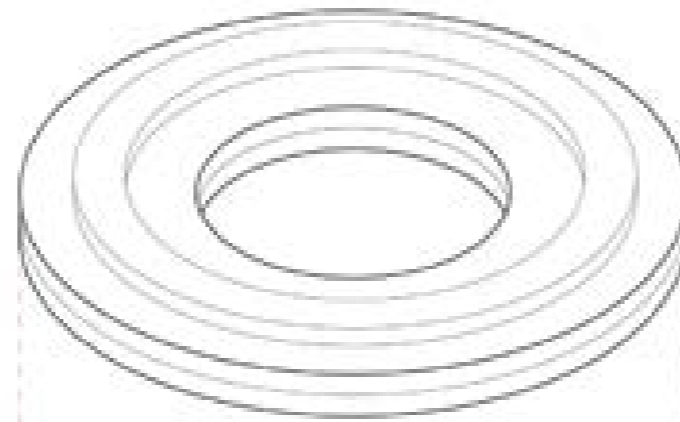

**ENTRANCE BUILDING**

- HALL-ATRIUM
- PANORAMIC TERRACE
- SKY LOUNGE
- UNIVERSITY SPACES
- UNIVERSITY CANTEEN
- LIBRARY

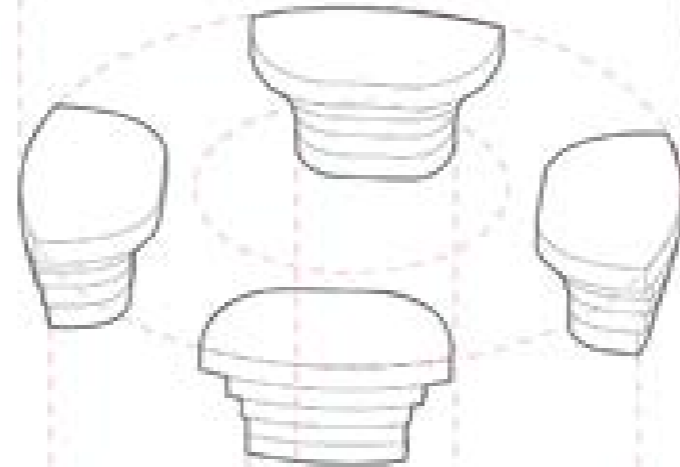

**PROGRAMS:**

- OPEN PLATFORMS
- MEETING ROOMS
- DIGITAL INFORMATION AREA
- OFFICES

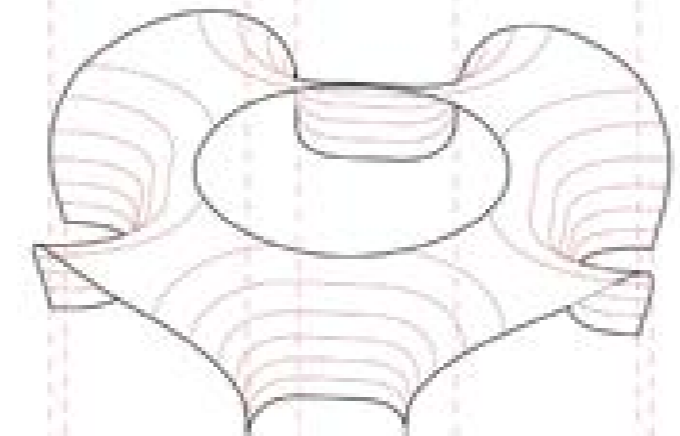

**MIRROR GLASS SURFACE**

The mirror reflects life of the open platform

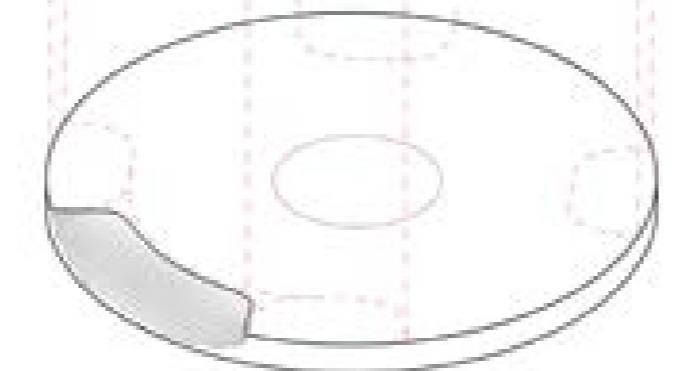

**GROUND FLOOR:**

**SERVICES TO THE PARK:**

- SECURITY
- TICKET SHOP
- SOUVENIR SHOP
- LOUNGE, CAFETERIA, HALL
- SMALL MUSEUM
- OPEN PLATFORM



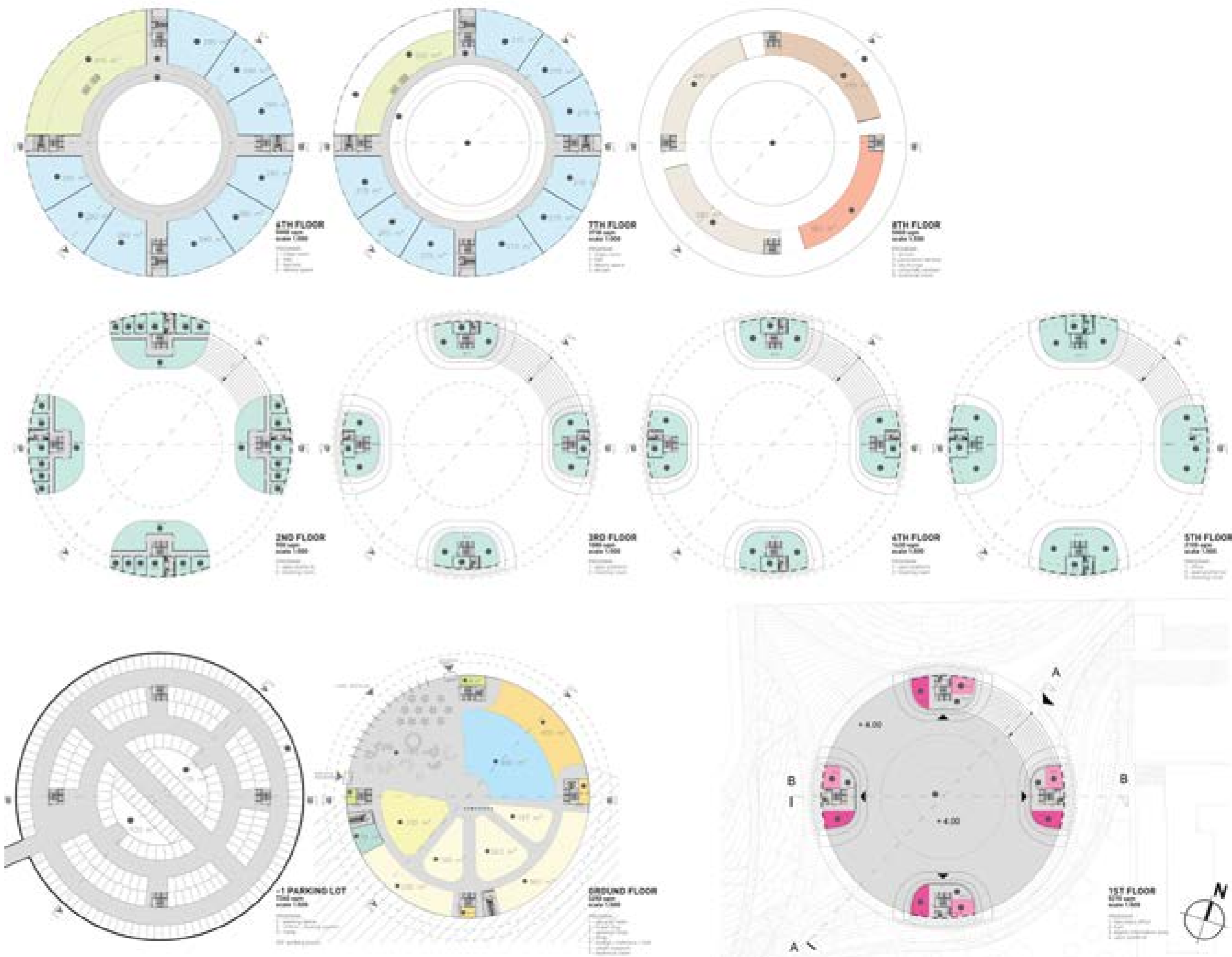

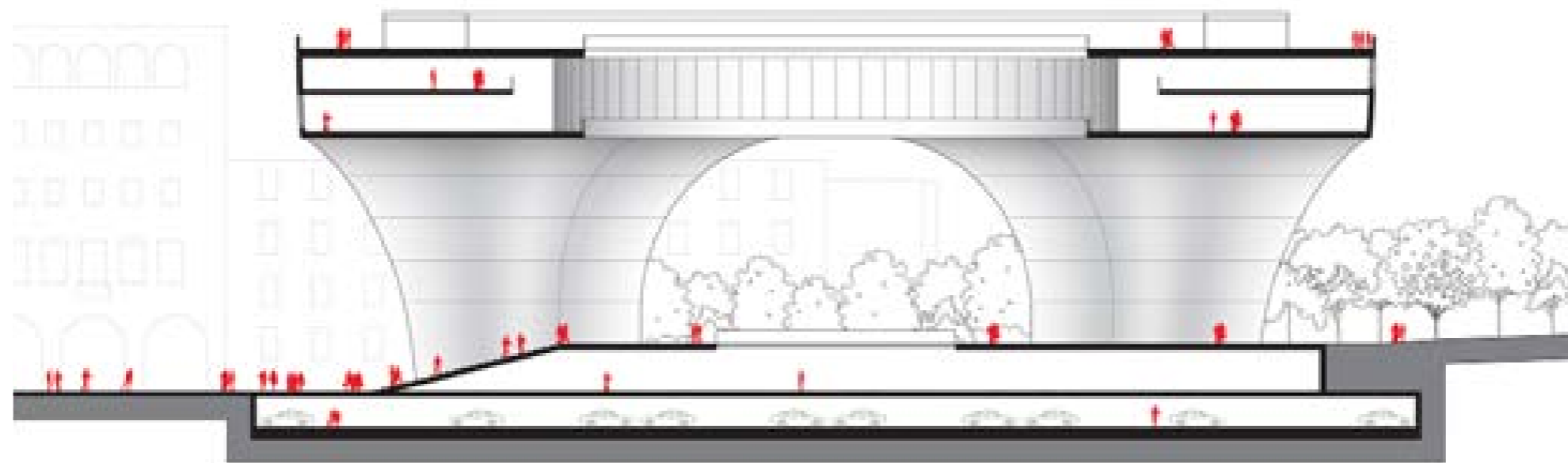

Section A-A

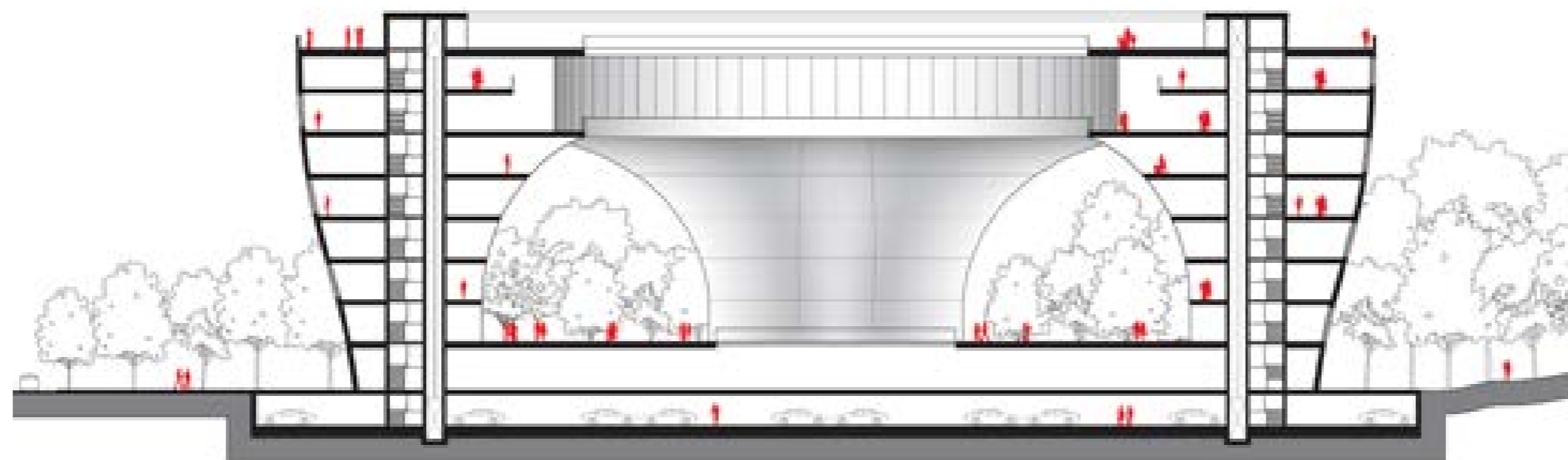

Section B-B

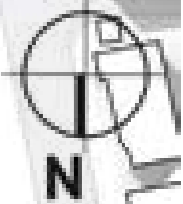

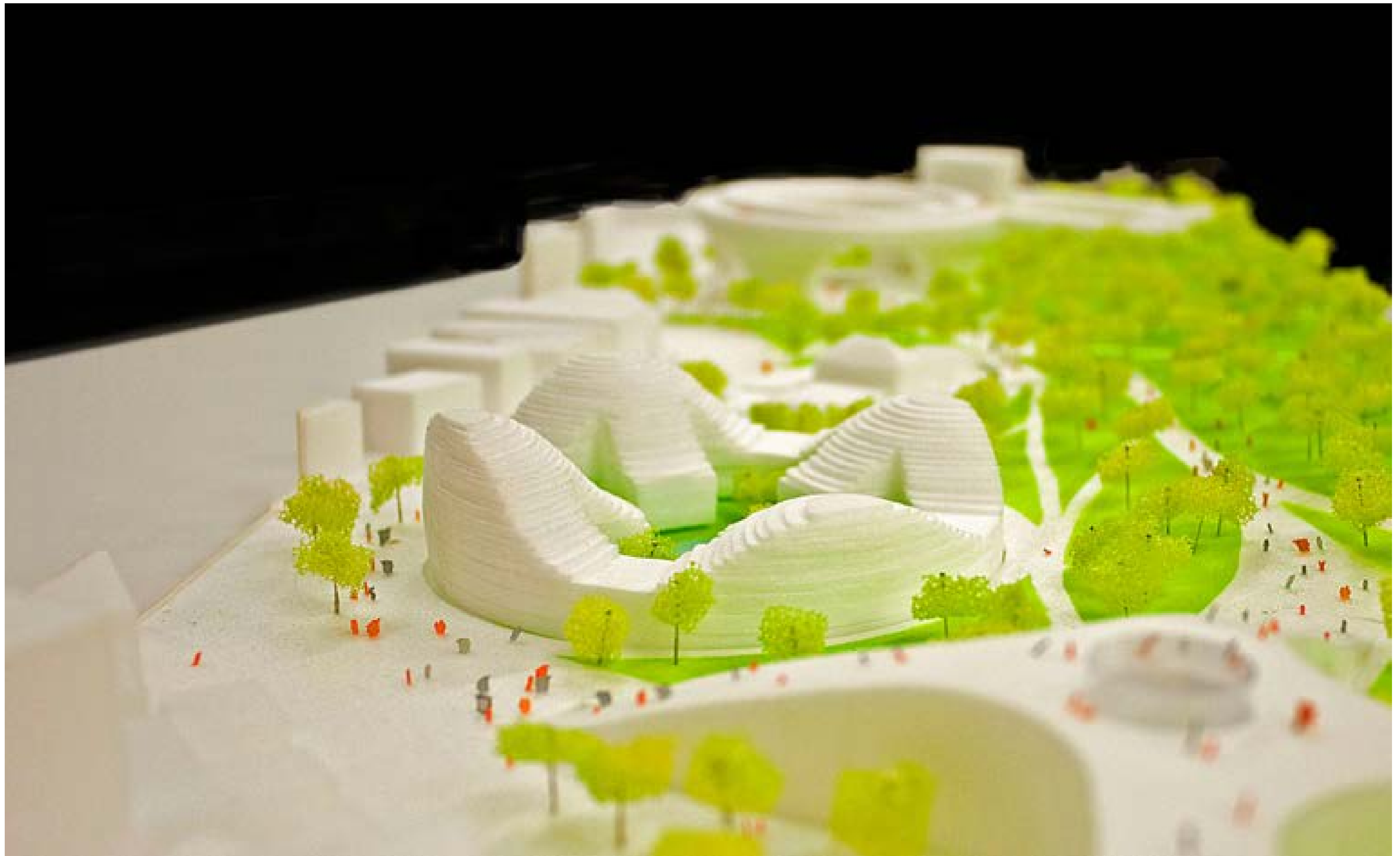

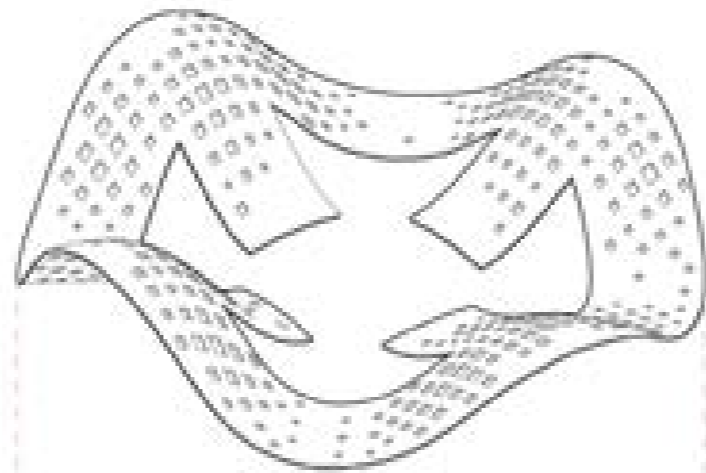

GENERAL  
DIRECTORATE

ROOF

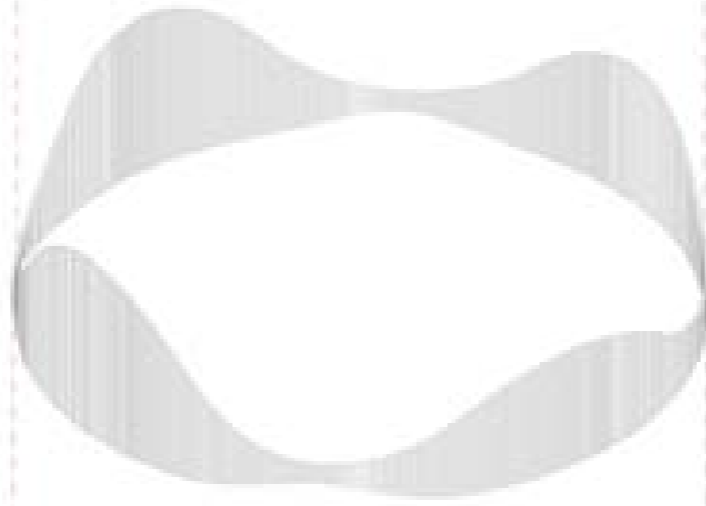

FACADE WITH  
VERTICAL  
SUNSHADING

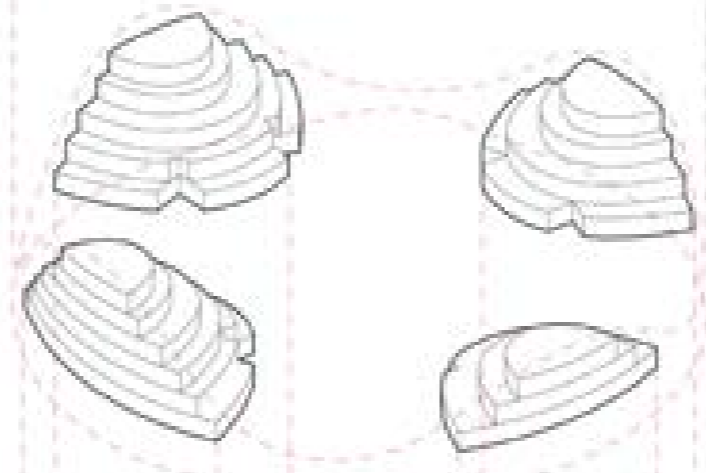

PROGRAMS:

- DEPARTMENTS
- DIRECTORATES

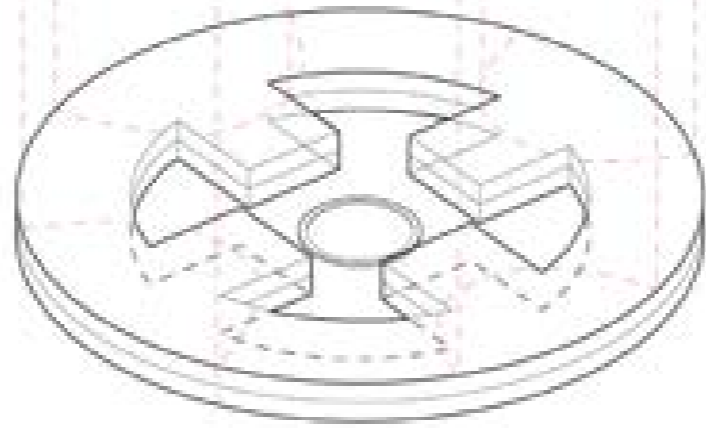

BASE and  
COURTYARD with  
WATER POND

- CRIMINALISTIC  
AND TECHNOLOGY  
DEPARTMENT
- BAR, RESTAURANT
- OFFICES
- LIBRARY



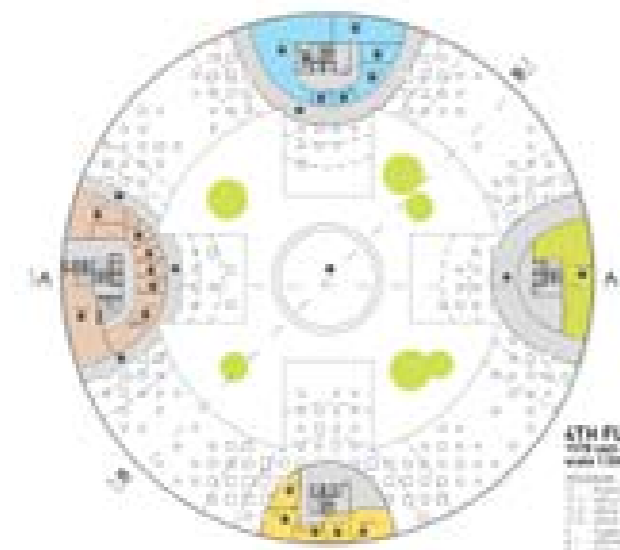

4TH FLOOR  
Area: 4,500 sqm

- 1. Office
- 2. Reception
- 3. Conference Room
- 4. Meeting Room
- 5. Break Room
- 6. Storage
- 7. Corridor
- 8. Elevator
- 9. Staircase

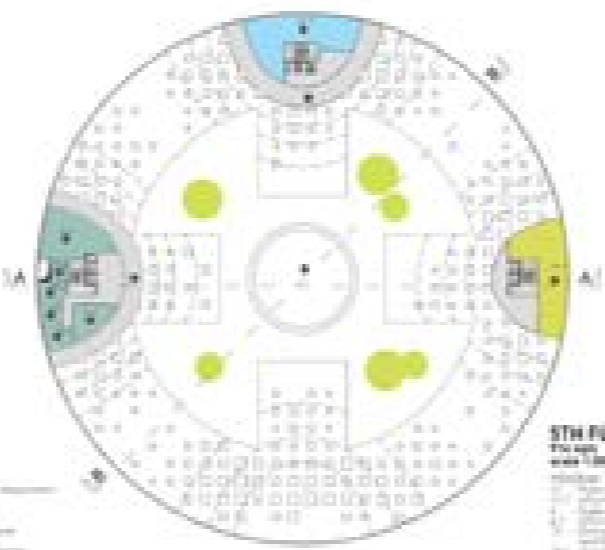

5TH FLOOR  
Area: 4,500 sqm

- 1. Office
- 2. Reception
- 3. Conference Room
- 4. Meeting Room
- 5. Break Room
- 6. Storage
- 7. Corridor
- 8. Elevator
- 9. Staircase

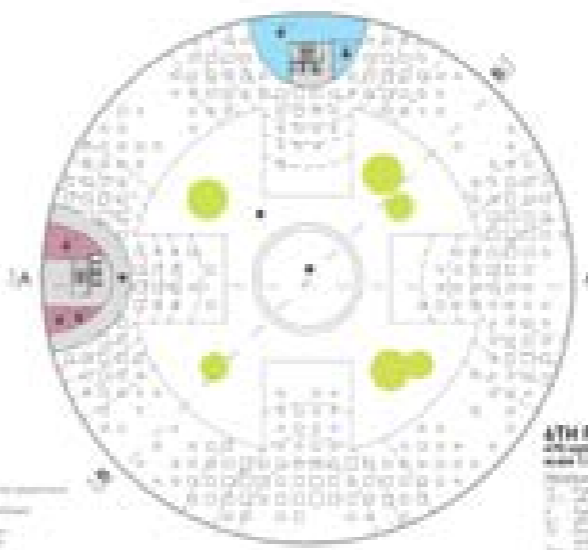

6TH FLOOR  
Area: 4,500 sqm

- 1. Office
- 2. Reception
- 3. Conference Room
- 4. Meeting Room
- 5. Break Room
- 6. Storage
- 7. Corridor
- 8. Elevator
- 9. Staircase

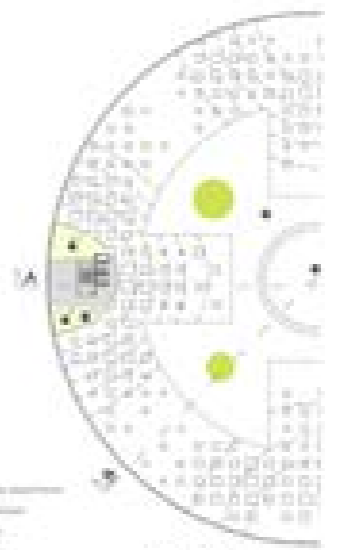

7TH FLOOR  
Area: 4,500 sqm

- 1. Office
- 2. Reception
- 3. Conference Room
- 4. Meeting Room
- 5. Break Room
- 6. Storage
- 7. Corridor
- 8. Elevator
- 9. Staircase



15TH FLOOR  
Area: 4,500 sqm

- 1. Office
- 2. Reception
- 3. Conference Room
- 4. Meeting Room
- 5. Break Room
- 6. Storage
- 7. Corridor
- 8. Elevator
- 9. Staircase

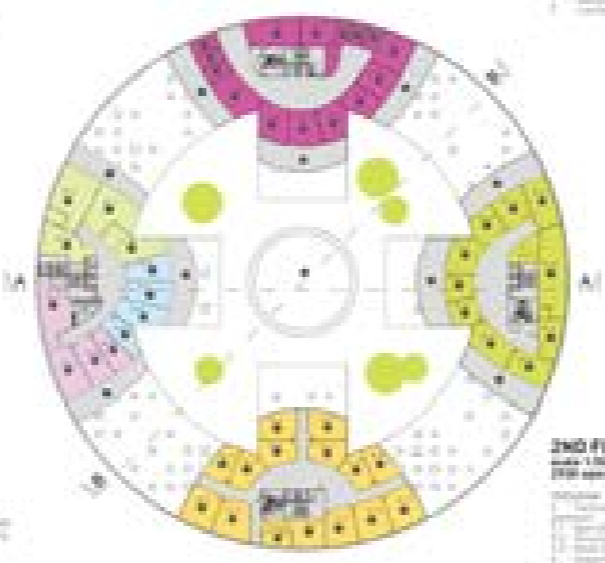

2ND FLOOR  
Area: 4,500 sqm

- 1. Office
- 2. Reception
- 3. Conference Room
- 4. Meeting Room
- 5. Break Room
- 6. Storage
- 7. Corridor
- 8. Elevator
- 9. Staircase

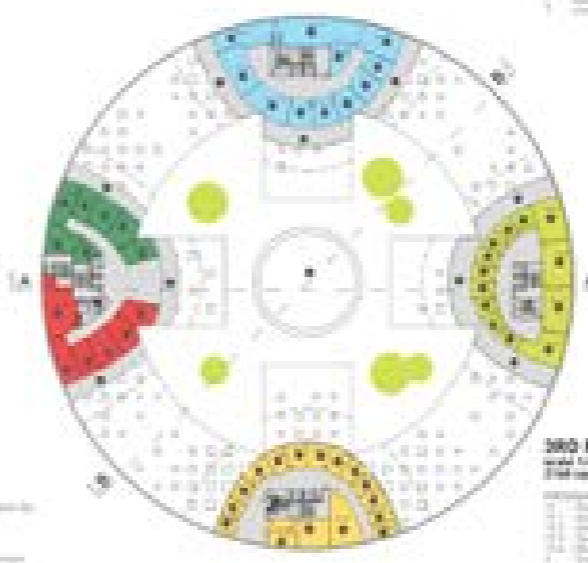

3RD FLOOR  
Area: 4,500 sqm

- 1. Office
- 2. Reception
- 3. Conference Room
- 4. Meeting Room
- 5. Break Room
- 6. Storage
- 7. Corridor
- 8. Elevator
- 9. Staircase

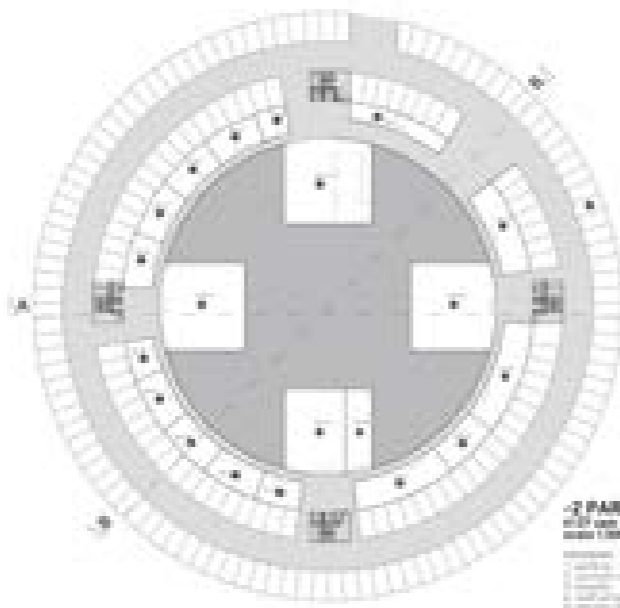

-2 PARKING LOT  
Area: 1,500 sqm

- 1. Parking
- 2. Corridor
- 3. Elevator
- 4. Staircase

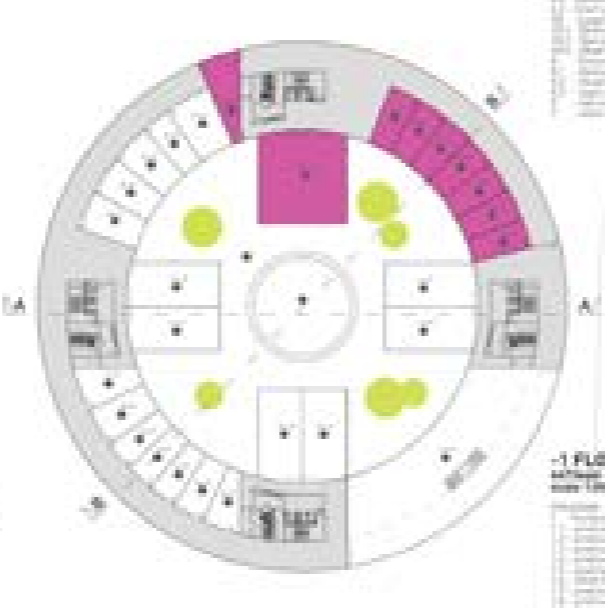

-1 FLOOR  
Area: 1,500 sqm

- 1. Parking
- 2. Corridor
- 3. Elevator
- 4. Staircase

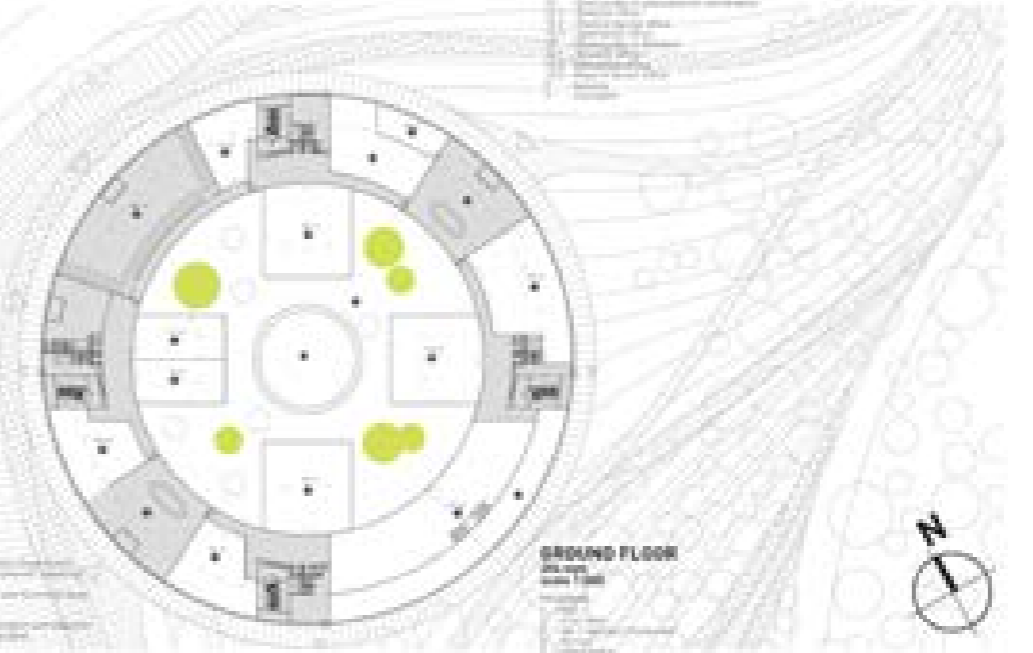

GROUND FLOOR  
Area: 20,000 sqm

- 1. Office
- 2. Reception
- 3. Conference Room
- 4. Meeting Room
- 5. Break Room
- 6. Storage
- 7. Corridor
- 8. Elevator
- 9. Staircase



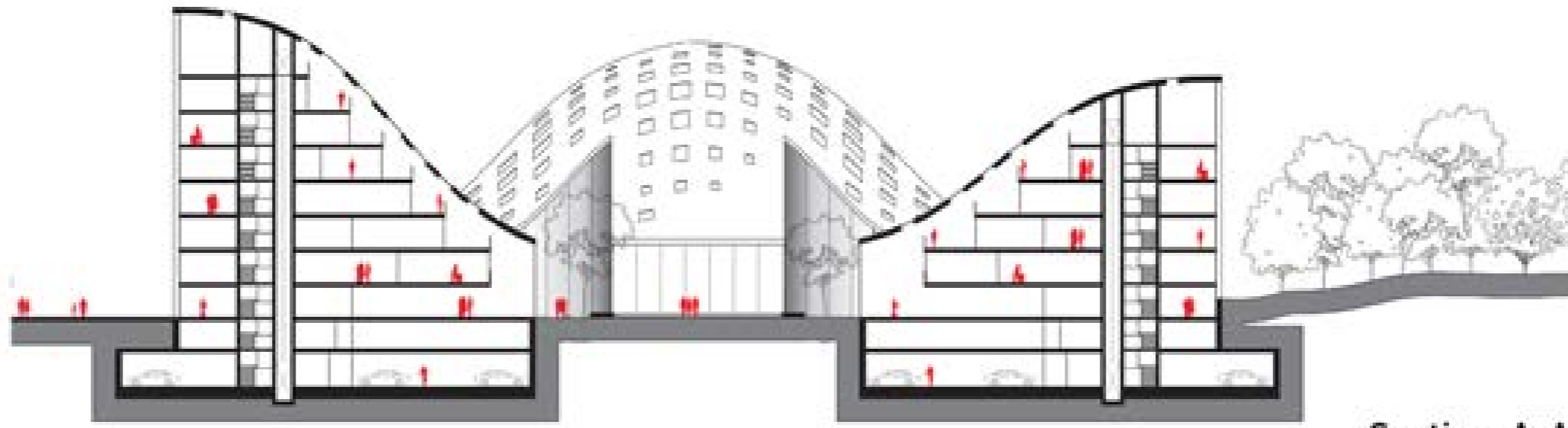

Section A-A

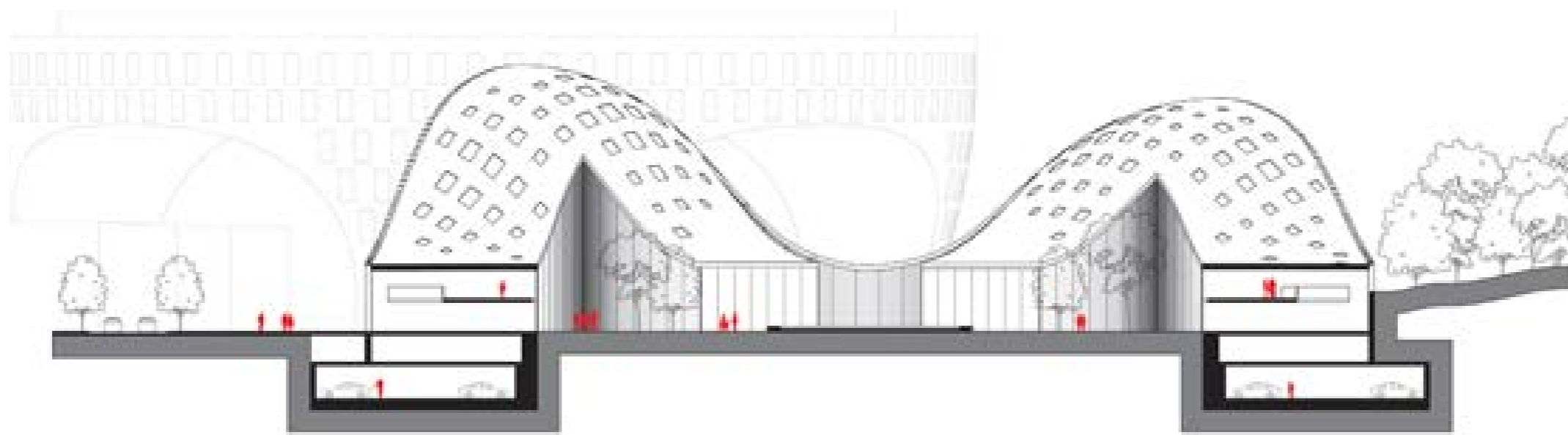

Section B-B



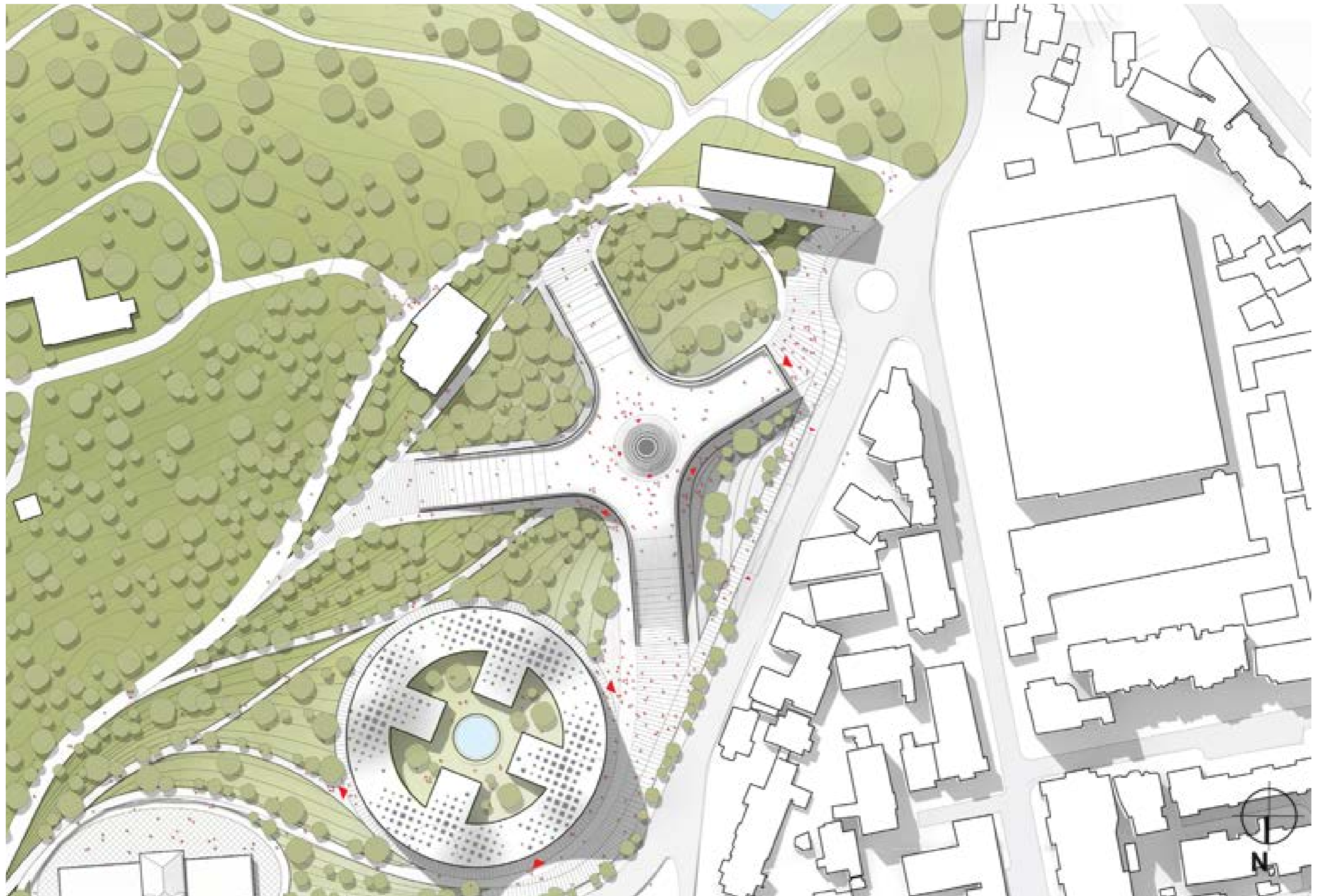



**PUBLIC SERVICE CENTRE**

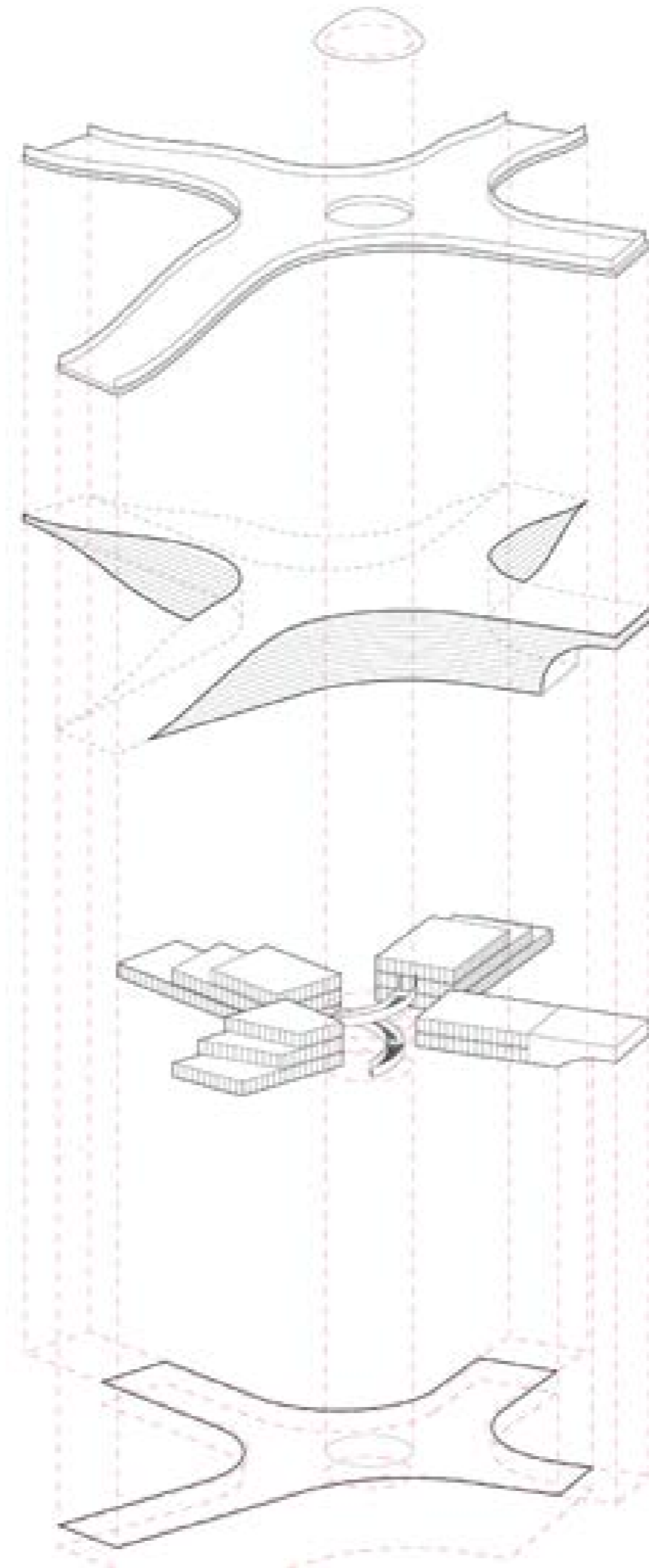

**PUBLIC SERVICE**

**GLASS DOME,  
ENTRANCE FROM  
THE PARK**

**ACCESSIBLE ROOF**

Accessible roof with  
possibility to enter  
the building through  
a glass dome.

**SUNSHADING  
OUTER SKIN**

**SERVICES and  
CIRCULATION CORE**

- OFFICES
- AUDITORIUM
- MEETING SPACES
- STORAGE AND  
SERVICE SPACES

**OPEN PUBLIC  
SERVICE SPACE**





PUBLIC SERVICE BUILDING

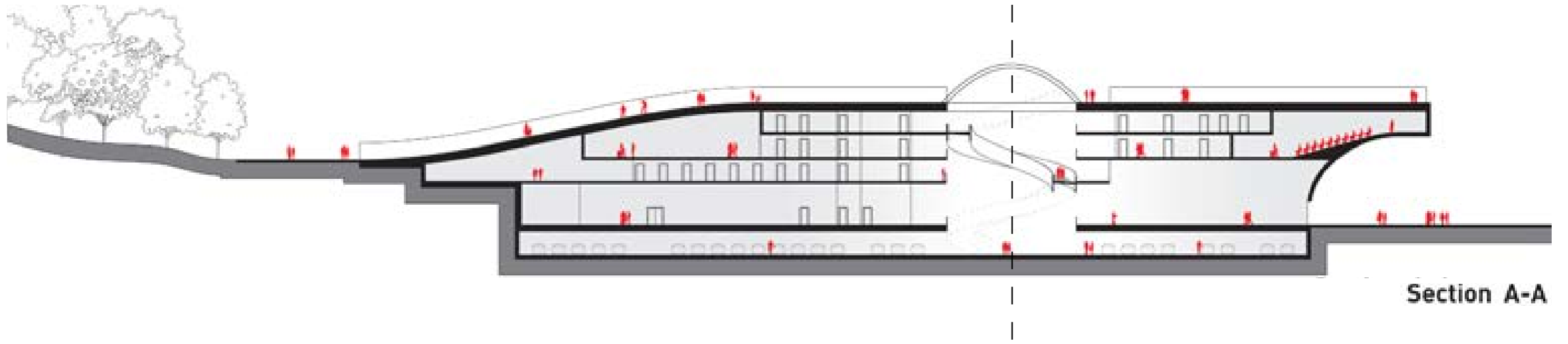

Section A-A

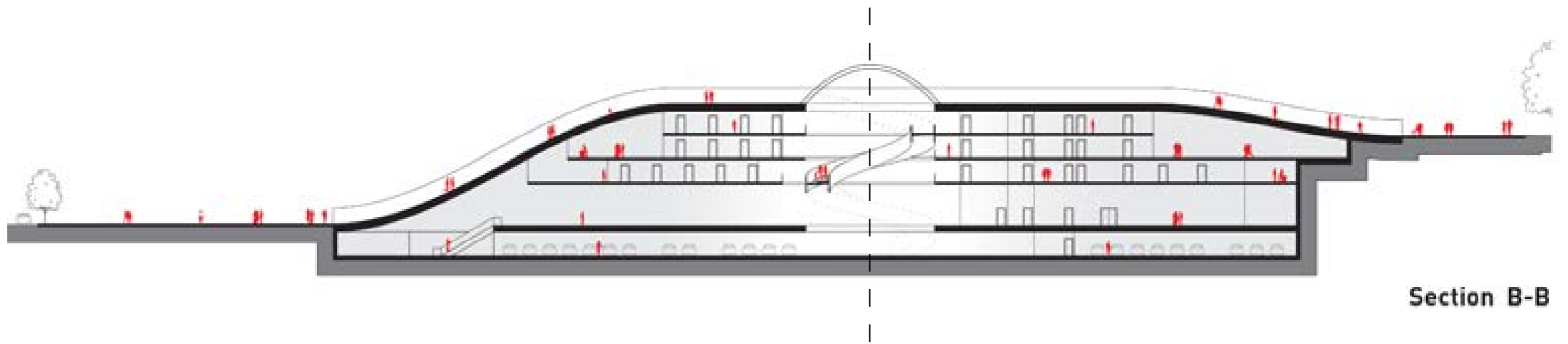

Section B-B



PUBLIC SERVICE CENTRE

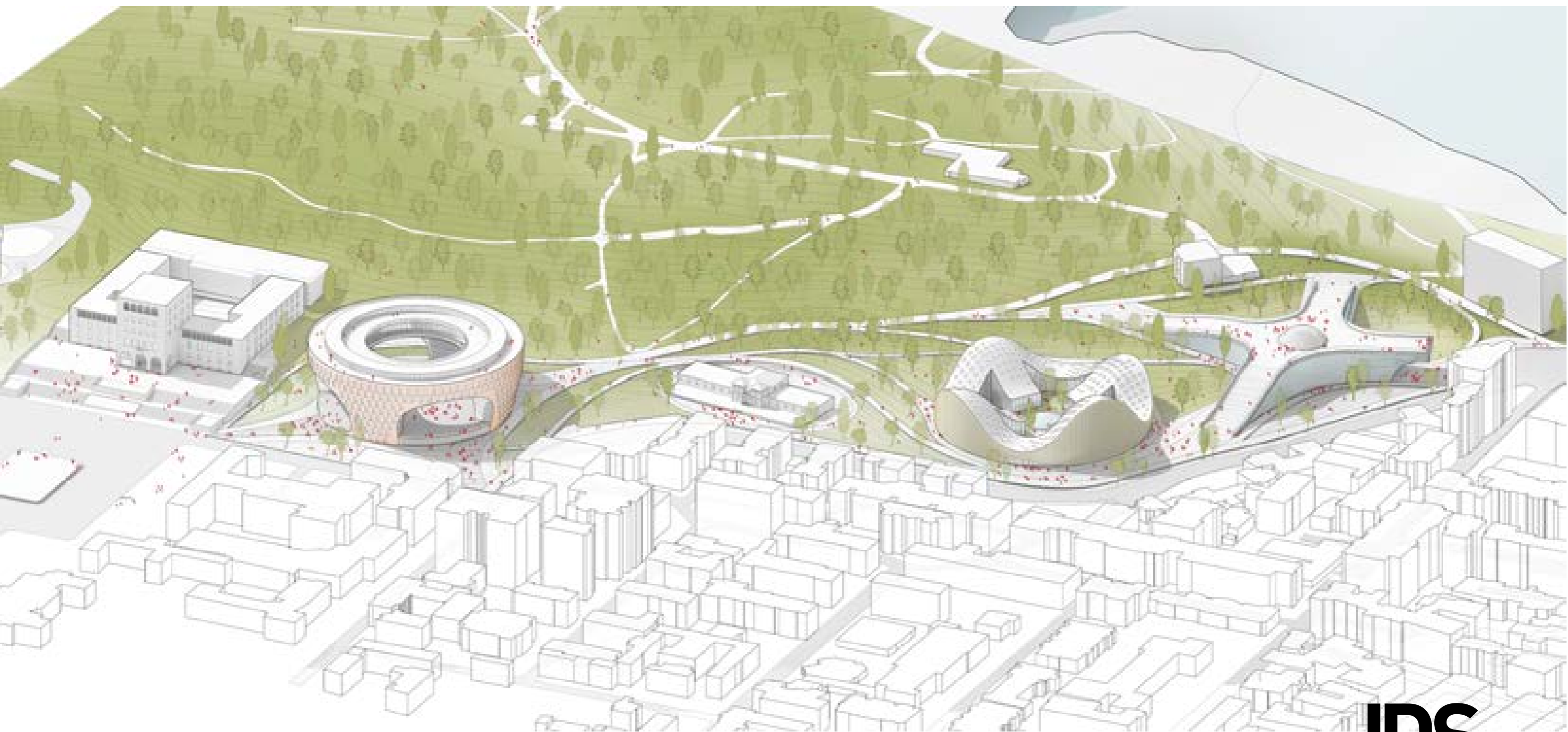

**JDS**  
JDS ARCHITECTS

 **deastudio**  
www.deastudio.com







